

FINITE STATE MACHINES

II. General FSMs

The *State* of the Machine

- The *state* can be encoded with a compact binary representation
 - Ex: 5 states
 - Minimum number of state bits = $\text{ceil}(\log_2(5)) = 3$ bits
 - Total possible states with 3 bits = $2^3 = 8$
 - There is probably limited value in optimizing which 5 of the 8 possible states you choose despite the fact you may have spent time looking at this in EEC 18. You could try in a critical situation.

II. General FSMs

The *State* of the Machine

- The *state* can be encoded with a “one-hot” representation
 - Ex: 5 states
 - Number of state bits = Number of states = 5 bits
 - No min, no max, no optimizing
 - 00001
 - 00010
 - 00100
 - 01000
 - 10000
 - + Zero-time state decode logic
 - + Very fast state increment (shift not addition)
 - Not practical for a very large number of states

II. General FSMs

The I/O of the Machine

- Typically the **outputs** of FSMs are derived from the state but often not a copy of the state as is often true with counters
 - Ex: counter `out = count;`
 - Ex: FSM `out = (state == DONE) && (x == 8'hF0);`
- Moore machines have outputs that are a function of the state only
- Mealy machines have outputs that are functions of the inputs which creates a purely-combinational path through the FSM from input to output which could limit the maximum clock frequency

II. General FSMs

3 Key Signal Groups

- One of the first steps in the design process is to identify and write down the following independent key signal names and word widths:

1. inputs

2. state

1. FSM state

2. counter(s)

3. outputs

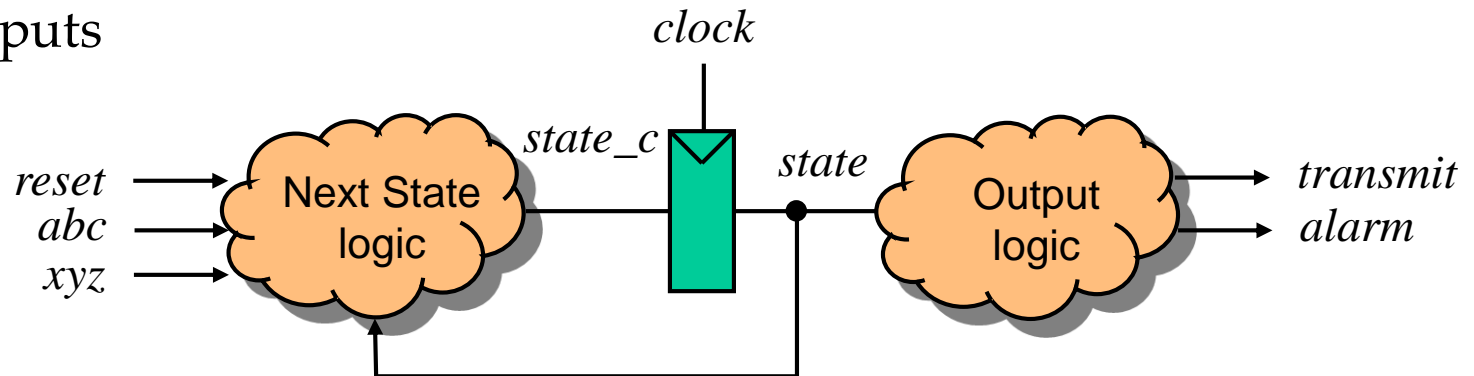

II. General FSMs

Major Components

- FSMs contain two major circuit structures

- 1) **State register** (row of FFs with their clocks tied together)

- 2) **Next State combinational logic**

- We could also include a third — **output logic** which is a function of state (Moore) or state and inputs (Mealy)

- Both (1) and (2) are usually coded with **always** blocks in verilog

- Always keep a clear picture of the output(s) and input(s) of each

- The Next State logic in this example:

- output(s) *state_c*

- input(s) *state, reset, abc, xyz*

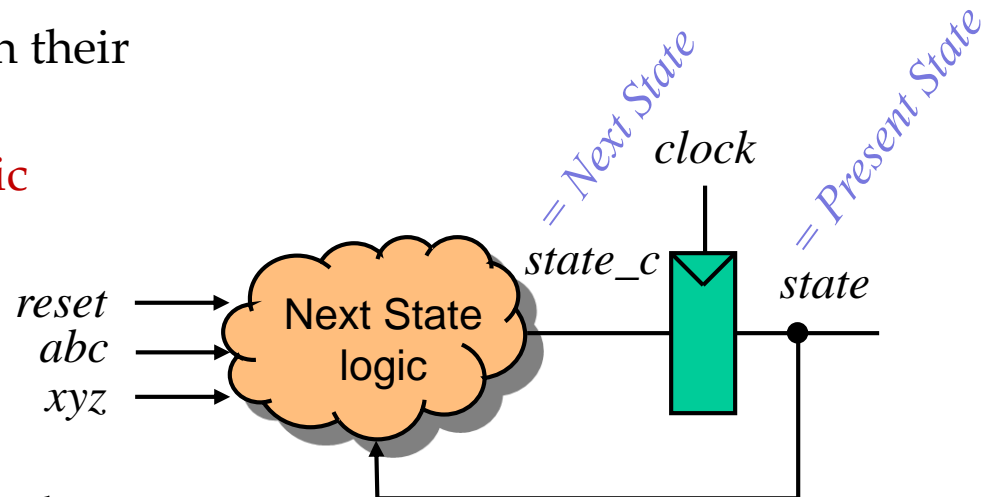

II. General FSMs

Next State Logic

- Give thought to the logic you are creating
- In many cases, it will be best to write statements that directly use inputs of the Next State logic rather than other internal combinational logic variables. For example, write logic as a function of reset, abc, xyz, and/or state; rather than state_c.
- In the example below, the longest path from the input(s) to the output *state_c* passes through **three** adders and a case selector (mux)

```
//--- Next State combinational logic
always @(state or xyz or abc or reset) begin
    ...

    // logic
    d = abc + 8'h01;    // no issues
    e = d + 8'h01;     // creates state + 2
    f = e + 8'h01;     // creates state + 3

    case (state) begin
        3'b000: state_c = d;
        3'b001: state_c = e;
        default: state_c = f;
    endcase

    ...
end
```

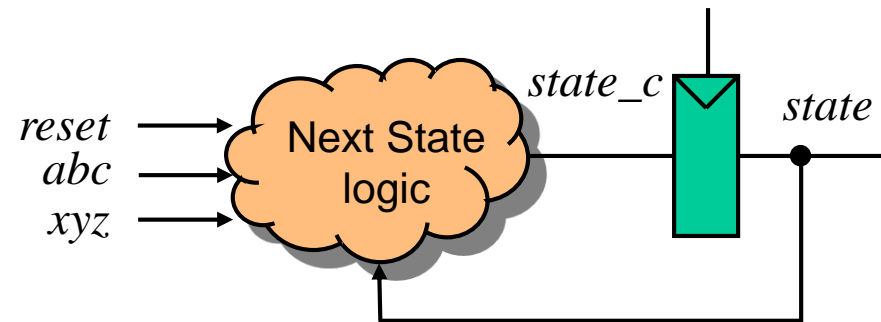

II. General FSMs

Next State Logic

- In the example below, the longest path from the input(s) to the output *state_c* passes through **one** adder and a case selector (mux)
- Even though the critical path is far shorter than the critical path of the previous example, the function is exactly the same

```
//--- Next State combinational logic
always @(freq or xyz or abc or reset) begin
    ...

    // logic
    d = abc + 8'h01;    // no issues
    e = abc + 8'h02;    // creates state + 2
    f = abc + 8'h03;    // creates state + 3

    case (state) begin
        3'b000: state_c = d;
        3'b001: state_c = e;
        default: state_c = f;
    endcase

    ...
end
```

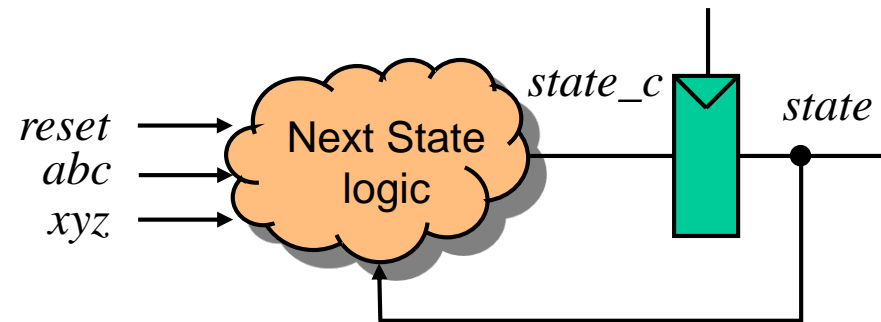

II. General FSMs

Next State Logic

- Example Next State combinational circuit with output **freq_c**
 - Always declare default values at beginning of always blocks
 - Use all of the best combinational logic design practices

```
//--- Next State combinational logic
always @(freq or xyz or abc or reset) begin
    // defaults
    freq_c = freq;    // an example

    // logic
    case (freq)
        ...
    endcase

    // logic
    if (xyz==4'b0010) begin
        ...
    end

    // reset logic is usually last for highest priority
    if (reset == 1'b1) begin
        freq_c = 3'b000;
    end
end
end
```

higher priority or precedence
gets the “final word”

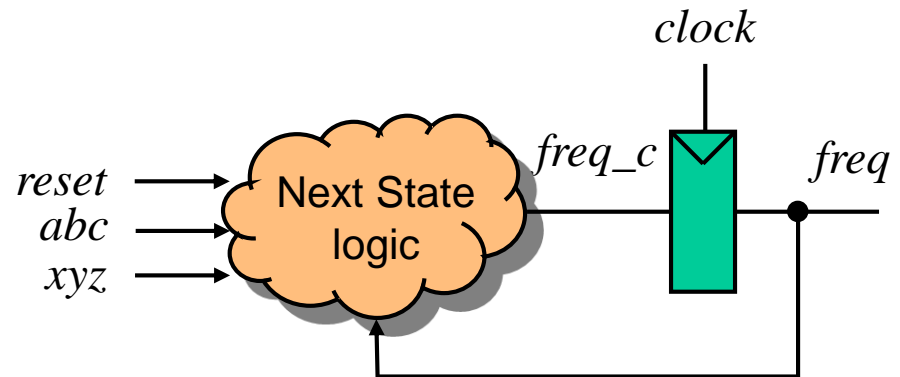

Five Things in Virtually Every Well-Designed Verilog State Machine

- 1) Default: `state_c = state;`
- 2) `case (state)`
- 3) `STATE: begin end` for each state. Partition design by *state*.
(In contrast, in traditional EEC18-style design, we partition the overall design by *bits of the state*.)
- 4) `if (reset == 1'b1)` at the end of the combinational `always` block
- 5) Instantiate FF register(s) in a separate `always` block

```
// Next State combinational logic
always @(state or reset or ...) begin
  // defaults
  state_c = state; // hold previous state

  case (state) begin
    INIT: begin
      ...
    end

    // Add a case target for each state

    default: c_freq = 3'bxxx; // error case
  endcase

  // reset logic often last for highest priority
  if (reset == 1'b1) begin
    state_c = 3'b000;
  end
end
```

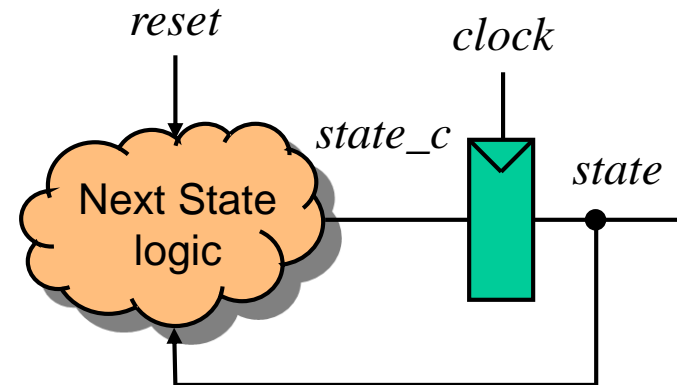

```
// instantiate the state register
always @(posedge clock) begin
  state <= #1 state_c;
end
```

Characteristics of a Well-Designed Verilog State Machine with Integrated Counters

1) In the default section, it is probably a good idea to have an auto-increment or auto-decrement statement

- `count_c = count + 8'h01; // Example increment`
- `count_c = count - 8'h01; // Example decrement`

2) In the “idle” or “wait” state, it is probably a good idea to hold the counter value to eliminate unnecessary toggling to reduce power dissipation

- `count_c = count; // Example hold counter value`
- `count_c = 8'h00; // Example hold counter at zero`

Finite State Design Example

- There are four states
 - **IDLE**
 - Go to PREP when *go* is asserted
 - **PREP**
 - Do something for 10 cycles
 - Then go to JOB1 if $x \leq 5$
 - Then go to JOB2 if $x > 5$
 - **JOB1**
 - Do something for 5 cycles
 - Then go to IDLE
 - **JOB2**
 - Do something for 20 cycles
 - Then go to IDLE
- *reset* at any time returns controller to IDLE state

State Diagram

- State diagram

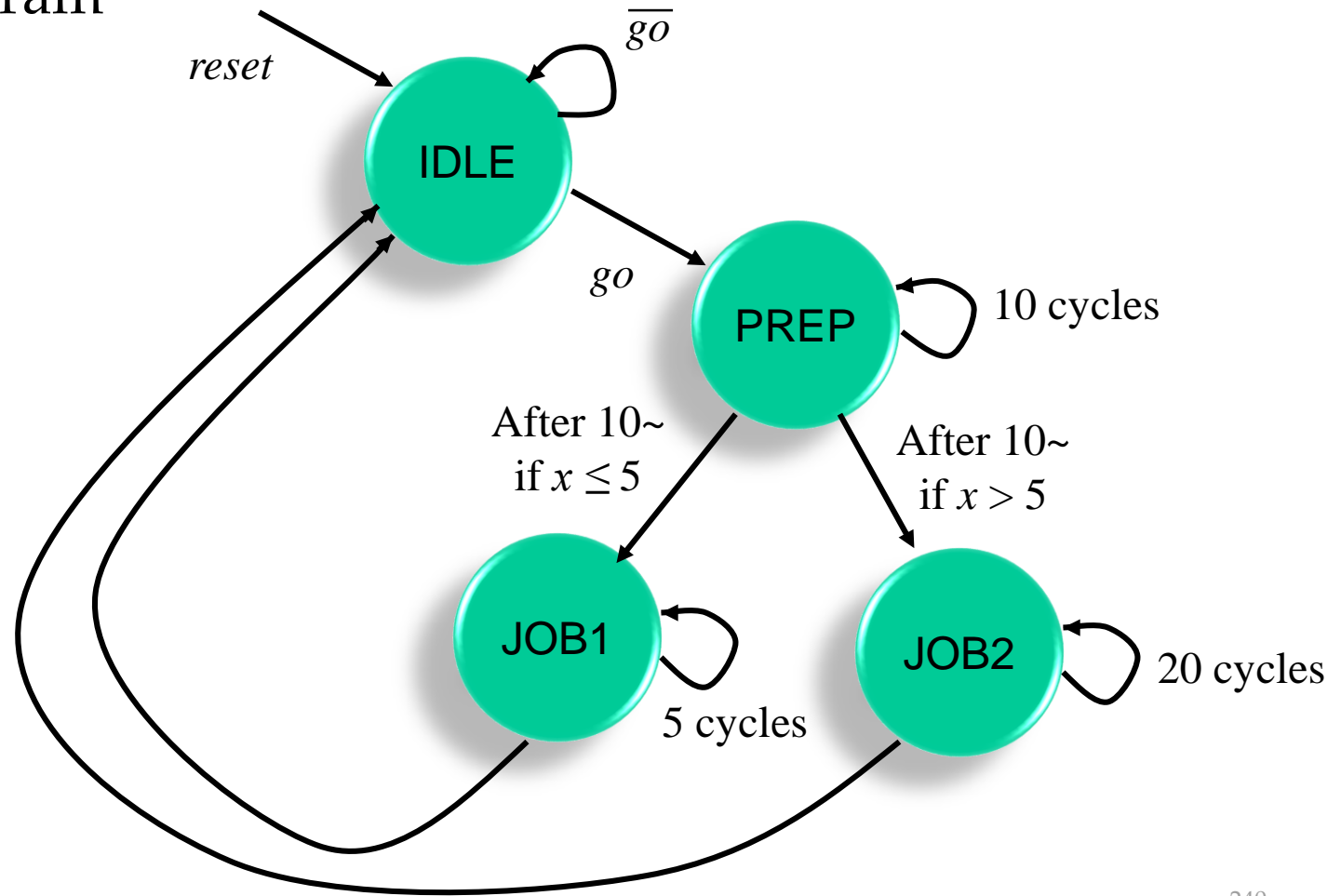

Control Block Example Solution (There are many solutions!)

- What are the *registers* (the values that need to be remembered)?
 1. `state` for the main controlling state machine
 2. `count` to count number of cycles in some of the states
- State registers
 - Choose two bits (obviously the minimum) for the four states
- Counter(s)
 - Choose three counters, one for each use – wasteful
 - Choose *one* five bit counter since states are independent and counter can be shared between different states
 - Counting *down* may be slightly better (simpler shared comparator for all cases that compare with zero when done)
- Keep registers (flip-flops) separate from state machine logic
 - Always do this for this class
- It is normally clearer to define states with names (such as **IDLE**) rather than constants (such as **2'b01**)

Circuit Diagram

- The Circuit diagram in this case is very similar to the detailed block diagram
- Inputs `reset, go, x[7:0]`
- FFs `state[1:0], count[4:0]`
- Outputs `not specified, probably driven by state[1:0]`

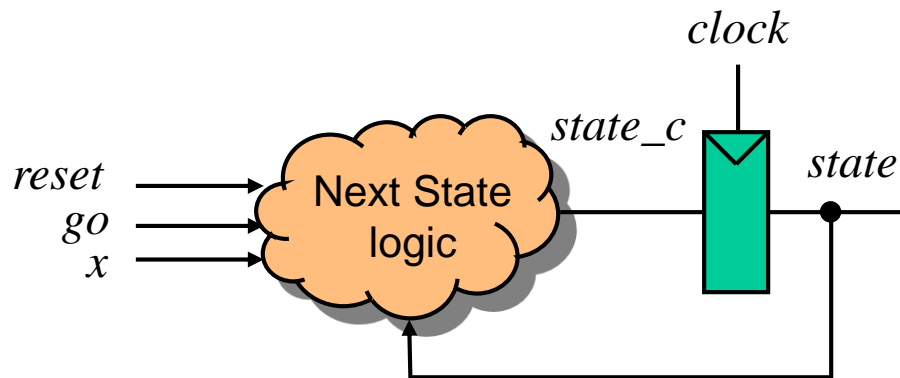

Example Verilog Implementation

fsm.v

```
parameter IDLE = 2'h0; // constants in hex notation
parameter PREP = 2'h1;
parameter JOB1 = 2'h2;
parameter JOB2 = 2'h3;

reg [1:0] state, state_c; // declare both FF regs
reg [4:0] count, count_c; // and comb. logic regs

// Combinational logic for state machine
always @(state or count or go or x or reset) begin
    // defaults (place first)
    state_c = state; // default same state
    count_c = count - 5'b00001; // default count down

    // main state machine logic
    case (state)
        IDLE: begin
            if (go == 1'b1) begin
                state_c = PREP;
                count_c = 5'd09; // constant in decimal
            end
            else begin
                count_c = 5'd00; // only for lower power
            end
        end

        PREP: begin
            if (count == 5'b00000) begin
                if (x <= 8'd005) begin // assume 8-bit x
                    state_c = JOB1; // goto JOB1
                    count_c = 5'd04;
                end
                else begin // goto JOB2
                    state_c = JOB2;
                    count_c = 5'd19;
                end
            end
        end
    end
end
```

```
JOB1: begin
    if (count == 5'b00000) begin
        state_c = IDLE;
        // count will underflow to -1 for 1~, no prob
    end
end

JOB2: begin
    if (count == 5'b00000) begin
        state_c = IDLE;
        // count will underflow to -1 for 1~, no prob
    end
end

default: begin // good practice, but not used here
    state_c = 2'bxx; // better for testing
    state_c = IDLE; // another option
end
endcase

// reset logic (place last to override other logic)
if (reset == 1'b1) begin
    state_c = IDLE;
    count_c = 5'b00000;
end

end // end of always block

// Instantiates registers (flip-flops)
always @(posedge clk) begin
    state <= #1 state_c;
    count <= #1 count_c;
end
```

I think it is better to put reset logic inside the control logic rather than with the FF declaration

NCVerilog simulation

- *reset_cold* to reset the clock oscillator
- *reset* to reset the state machine
- IDLE → PREP → **JOB1** (since $x[7:0] \leq 8'd05$)

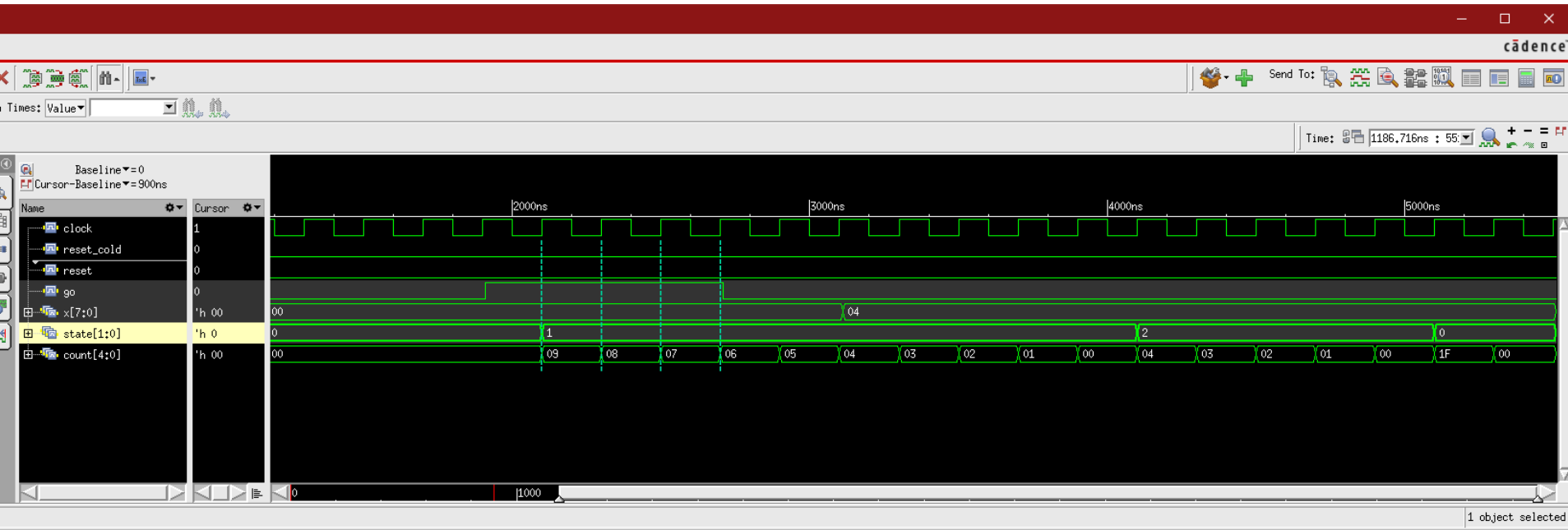

Design Compiler Synthesis

Complete Gate Netlist

Related to *count*

```
DFF_X1 \count_reg[2] ( .D(count_c[2]), .CK(clk), .Q(count[2]), .QN(n35) );
DFF_X1 \count_reg[3] ( .D(count_c[3]), .CK(clk), .Q(count[3]) );
DFF_X1 \count_reg[4] ( .D(count_c[4]), .CK(clk), .Q(count[4]) );
DFF_X1 \count_reg[1] ( .D(count_c[1]), .CK(clk), .Q(count[1]) );
DFF_X1 \count_reg[0] ( .D(count_c[0]), .CK(clk), .Q(count[0]), .QN(N8) );
XOR2_X1 U33 ( .A(count[3]), .B(n33), .Z(n29) );
XNOR2_X1 U34 ( .A(count[4]), .B(n34), .ZN(n30) );
OAI22_X1 U36 ( .A1(n21), .A2(n42), .B1(n40), .B2(n18), .ZN(count_c[2]) );
NOR3_X1 U41 ( .A1(count[1]), .A2(count[0]), .A3(n26), .ZN(n17) );
OR3_X1 U42 ( .A1(count[4]), .A2(count[3]), .A3(count[2]), .ZN(n26) );
OAI22_X1 U45 ( .A1(reset), .A2(n20), .B1(n21), .B2(n30), .ZN(count_c[4]) );
OAI22_X1 U46 ( .A1(reset), .A2(n22), .B1(n21), .B2(n29), .ZN(count_c[3]) );
OAI22_X1 U47 ( .A1(reset), .A2(n20), .B1(n21), .B2(n31), .ZN(count_c[1]) );
NOR2_X1 U53 ( .A1(reset), .A2(n25), .ZN(count_c[0]) );
NOR2_X1 U56 ( .A1(count[1]), .A2(count[0]), .ZN(n32) );
AOI21_X1 U57 ( .B1(count[0]), .B2(count[1]), .A(n32), .ZN(n31) );
NOR2_X1 U60 ( .A1(count[3]), .A2(n33), .ZN(n34) );
```

Related to *state*

```
DFF_X1 \state_reg[1] ( .D(n28), .CK(clk), .Q(state[1]), .QN(n4) );
DFF_X1 \state_reg[0] ( .D(n27), .CK(clk), .Q(state[0]), .QN(n7) );
NAND3_X1 U27 ( .A1(n17), .A2(state[0]), .A3(N23), .ZN(n16) );
NOR2_X1 U43 ( .A1(n7), .A2(state[1]), .ZN(n23) );
AOI22_X1 U48 ( .A1(state[1]), .A2(n17), .B1(go), .B2(n4), .ZN(n19) );

NAND3_X1 U28 ( .A1(n43), .A2(n41), .A3(n19), .ZN(n14) );
NAND3_X1 U29 ( .A1(n17), .A2(n41), .A3(n23), .ZN(n18) );
NAND2_X1 U30 ( .A1(n24), .A2(n41), .ZN(n21) );
NAND3_X1 U31 ( .A1(n7), .A2(n4), .A3(go), .ZN(n22) );
NAND3_X1 U32 ( .A1(n17), .A2(n40), .A3(n23), .ZN(n20) );
INV_X1 U35 ( .A(n20), .ZN(n39) );
INV_X1 U37 ( .A(N10), .ZN(n42) );
INV_X1 U38 ( .A(N23), .ZN(n40) );
INV_X1 U39 ( .A(n23), .ZN(n43) );
INV_X1 U40 ( .A(n36), .ZN(n37) );
OAI21_X1 U44 ( .B1(n17), .B2(n43), .A(n4), .ZN(n24) );
OAI21_X1 U49 ( .B1(n7), .B2(n14), .A(n15), .ZN(n27) );
NAND4_X1 U50 ( .A1(n16), .A2(n14), .A3(n41), .A4(n4), .ZN(n15) );
OAI21_X1 U51 ( .B1(n4), .B2(n14), .A(n18), .ZN(n28) );
INV_X1 U52 ( .A(reset), .ZN(n41) );
AOI211_X1 U54 ( .C1(N8), .C2(n24), .A(n39), .B(n38), .ZN(n25) );
INV_X1 U55 ( .A(n22), .ZN(n38) );
NAND2_X1 U58 ( .A1(n32), .A2(n35), .ZN(n33) );
OAI21_X1 U59 ( .B1(n32), .B2(n35), .A(n33), .ZN(N10) );
AOI211_X1 U61 ( .C1(x[2]), .C2(x[1]), .A(x[4]), .B(x[3]), .ZN(n36) );
NOR4_X1 U62 ( .A1(n37), .A2(x[5]), .A3(x[7]), .A4(x[6]), .ZN(N23) );
```

Relationship
is unclear